



CONE CLIMBER 3000

TAY- CC05-CC3000-00

EN1176-1:2017

EN1176-11:2014





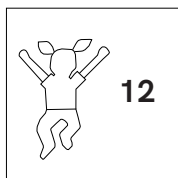



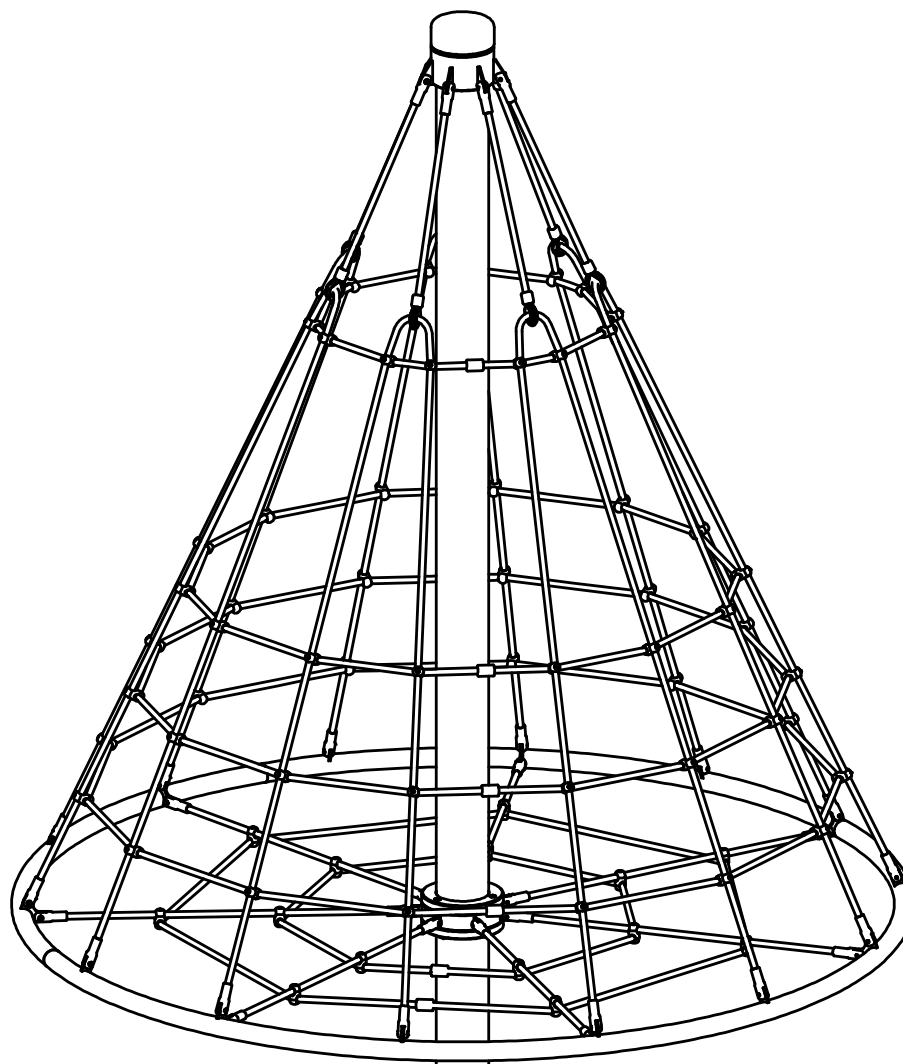







3+





Ø 6.4m







1		SW82740	19kg
1		SW82724	6kg
1		SW82063	15kg
1		SW82016	9kg
1		TAY-51212	
1		SW82045	40kg
1		M8x100 A2 CSK SCS	
1		SW81995	1kg
1		SW82026	3kg
1		SW81996	1kg
1		M8 A2 NYLOC	
35		SW82232	
35		SW82233	
35		M6x25 A2	

S6 
 EN1176
 2050mm

S14 
 m²
 32.2

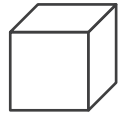
S13 
 m³
 0.72

S15 
 L x W x H (m)
 6.4 x 6.4 x 3.0

S23 
 T30H

S20 
 8 X 24

S12 
 kg
 94



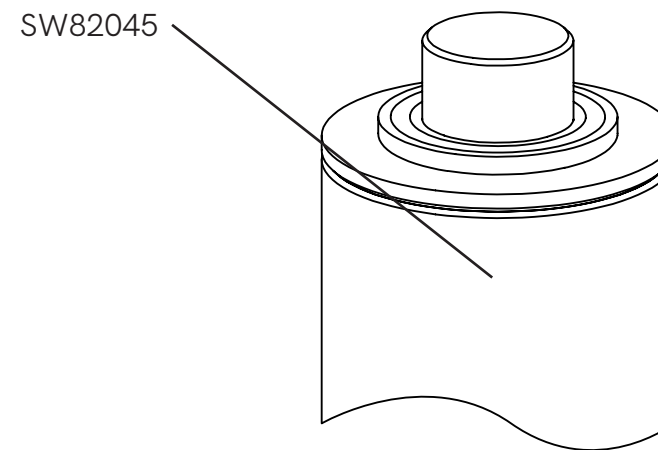
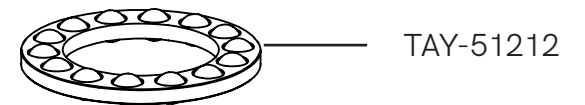
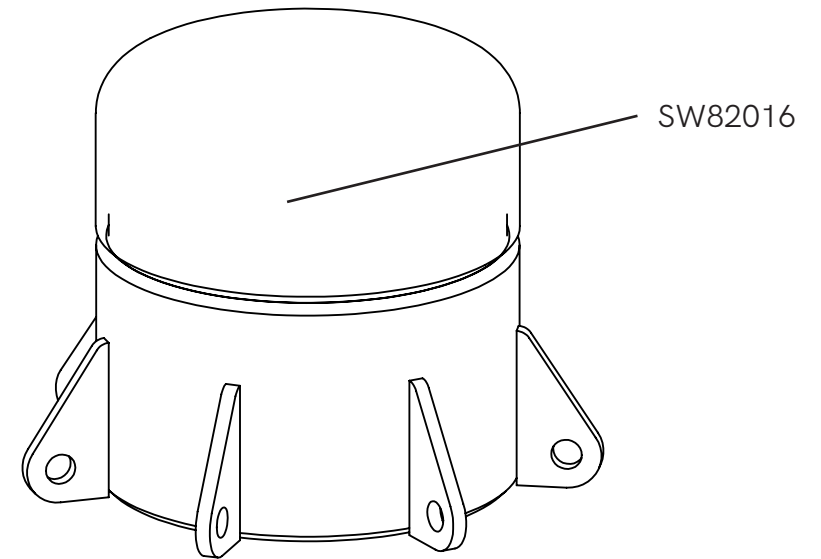
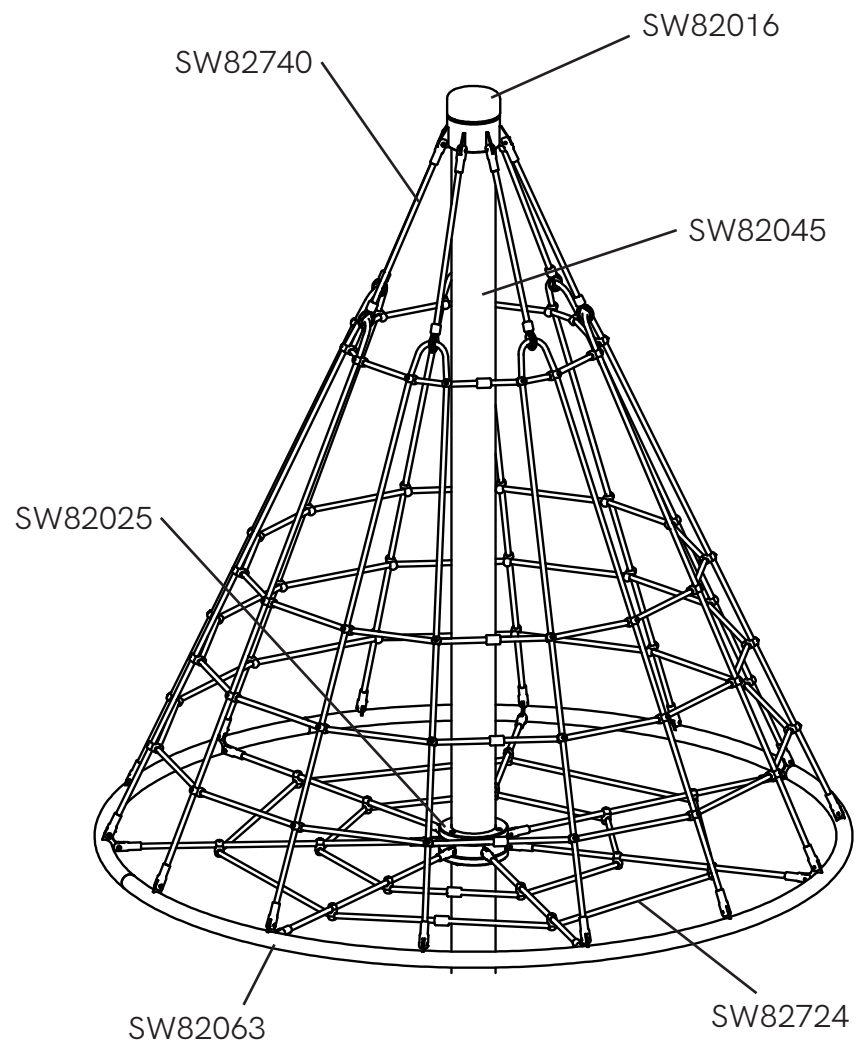

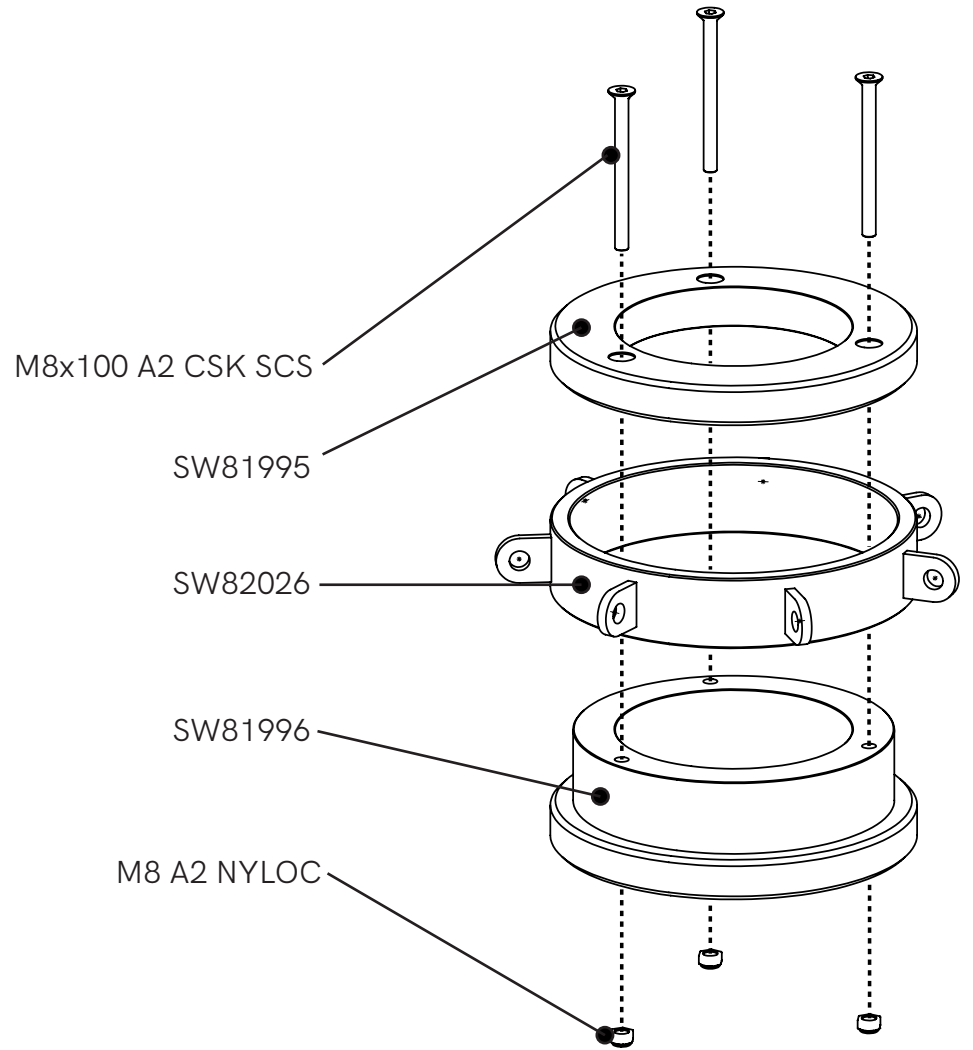
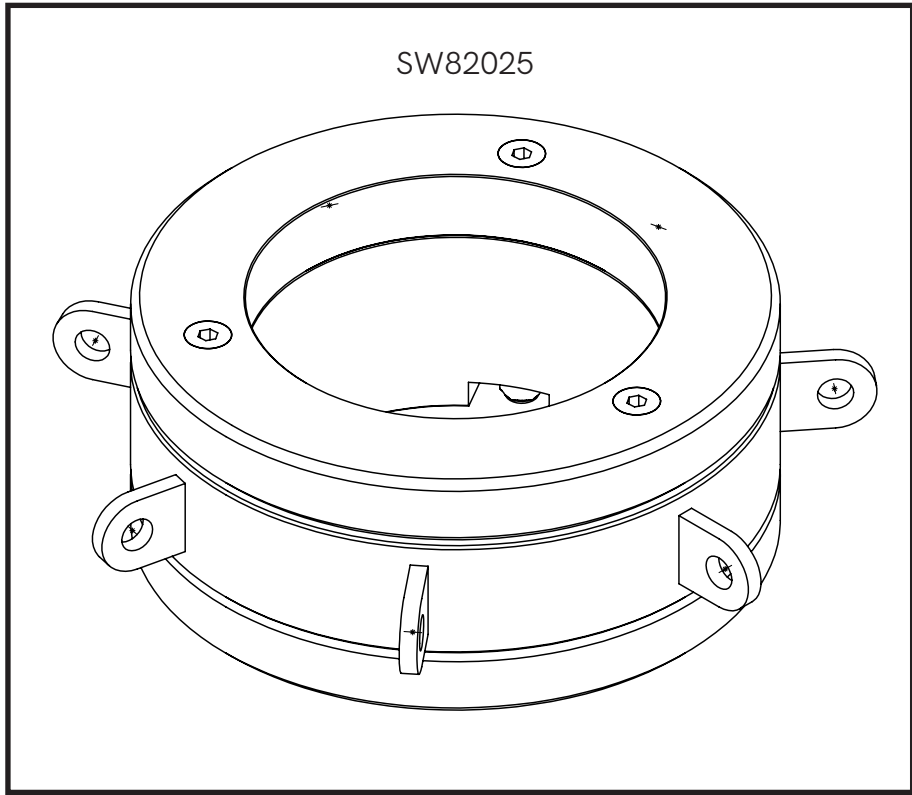

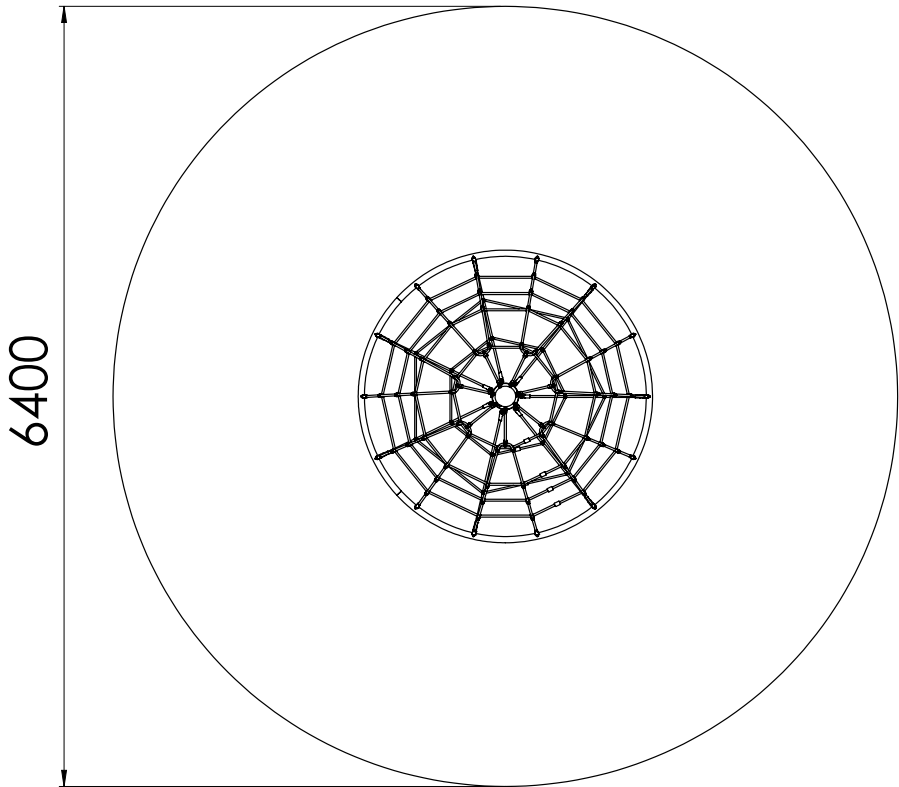
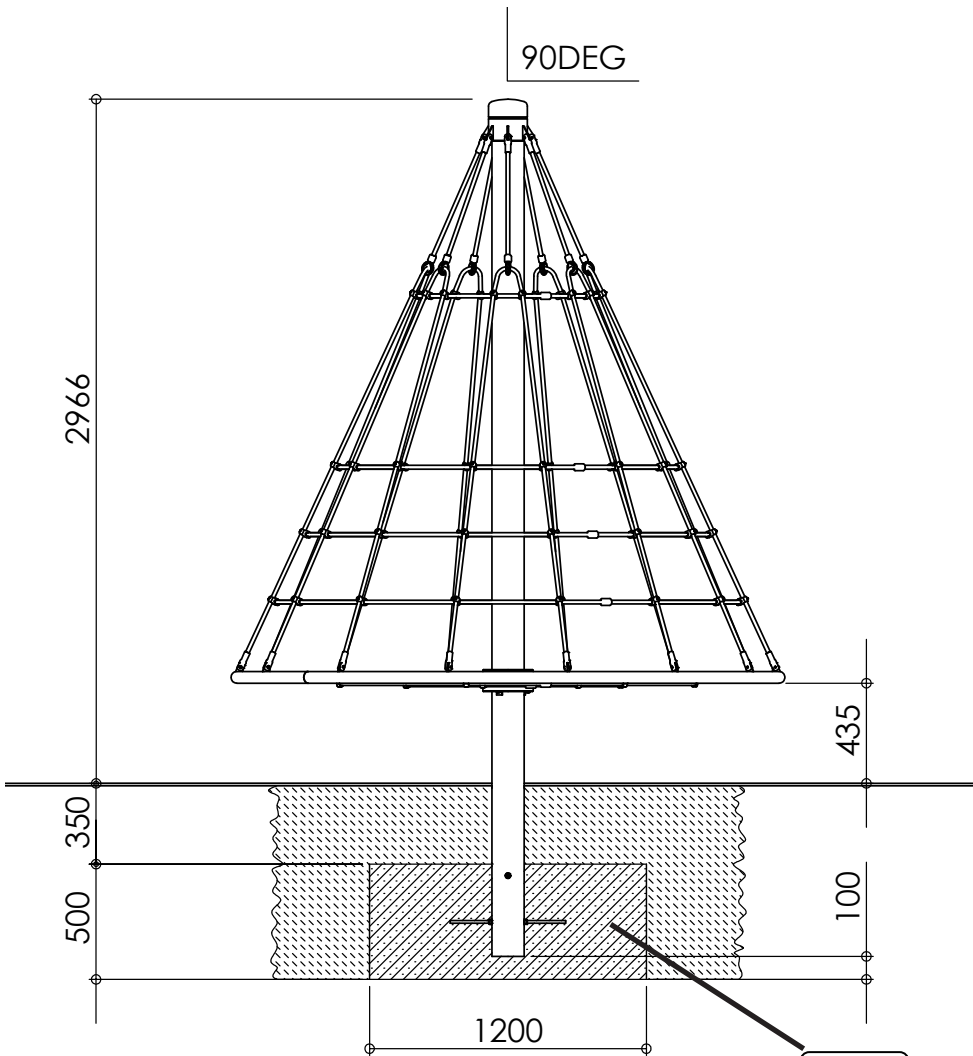
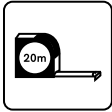

0.72m³
30N/mm²



TAY- CC05-CC3000-00

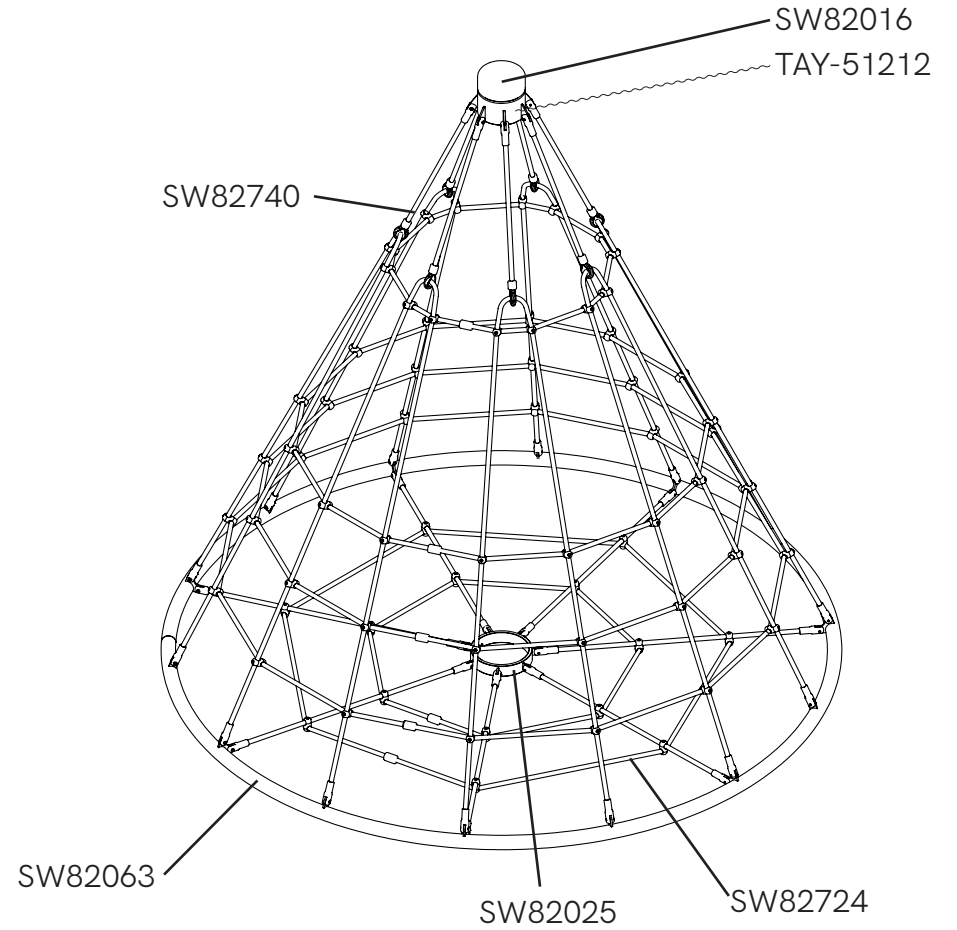
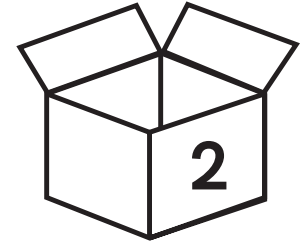
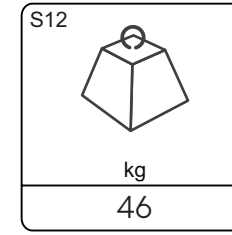
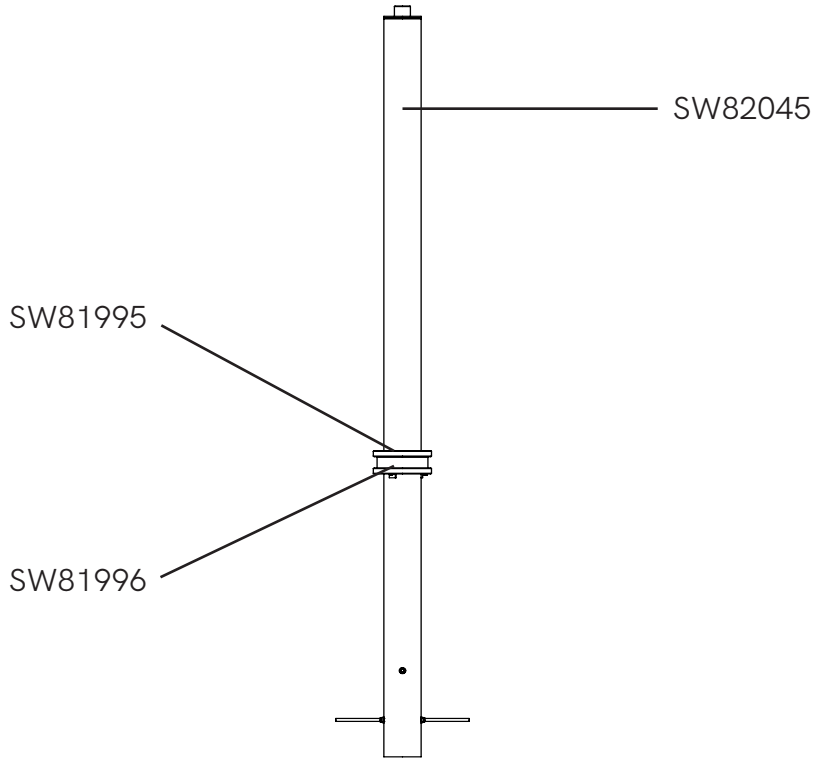
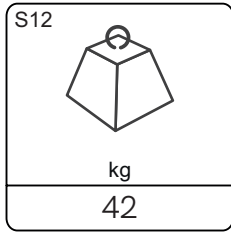
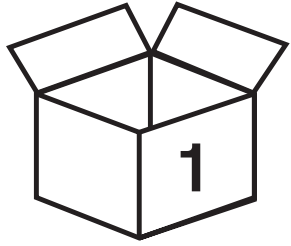

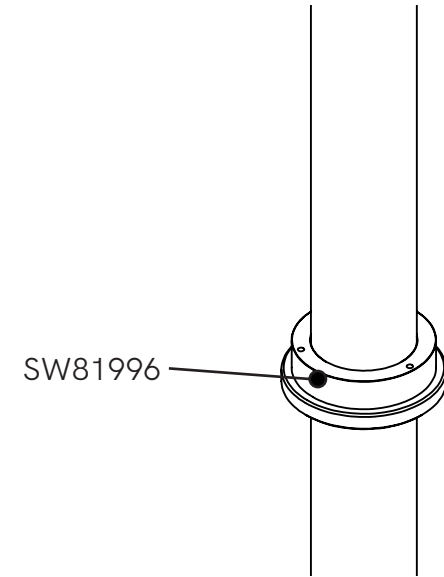
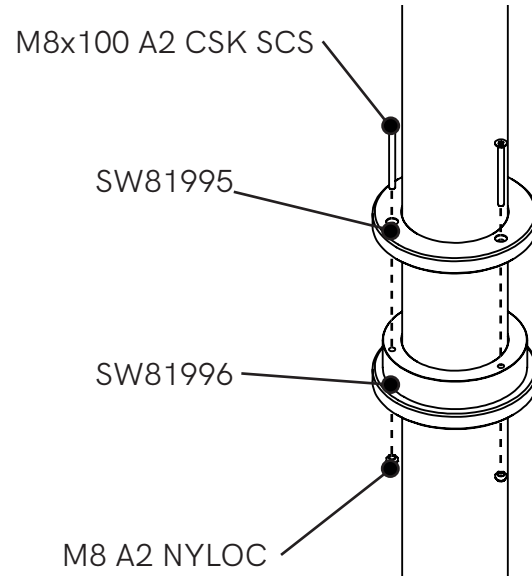
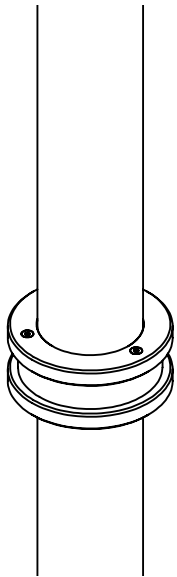
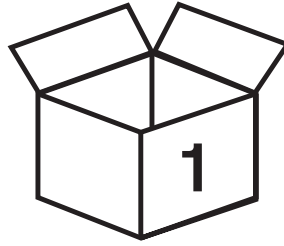
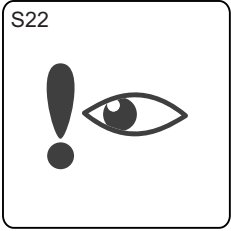

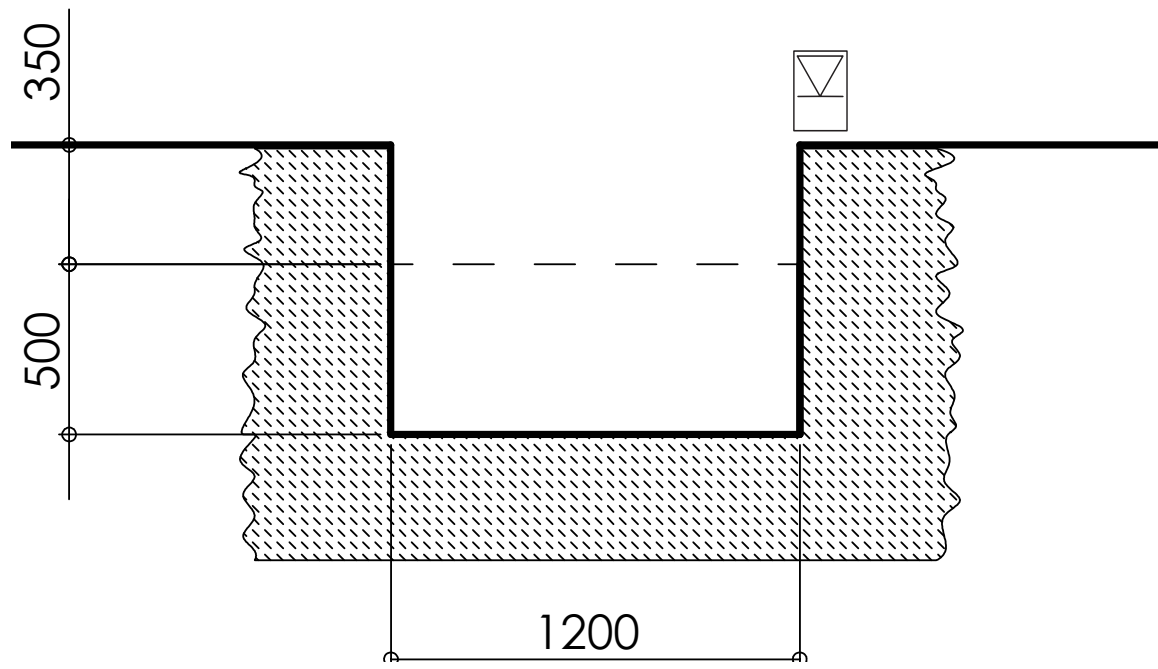
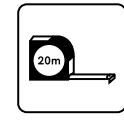
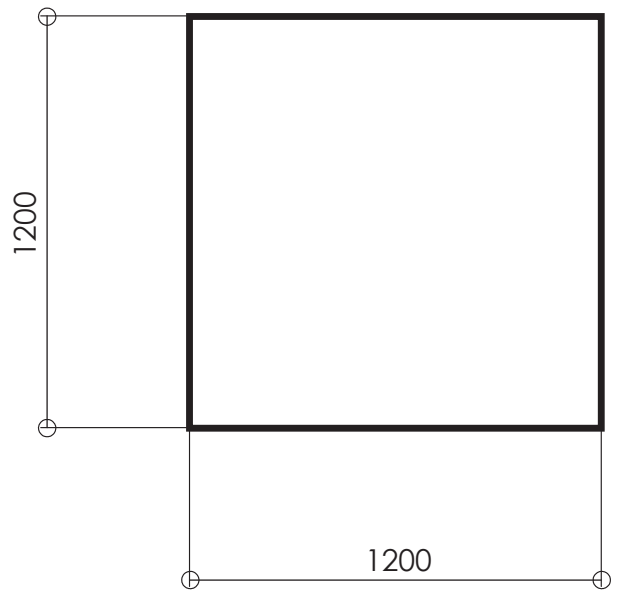

TAY- CC05-CC3000-00

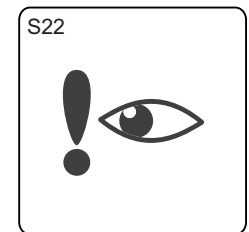
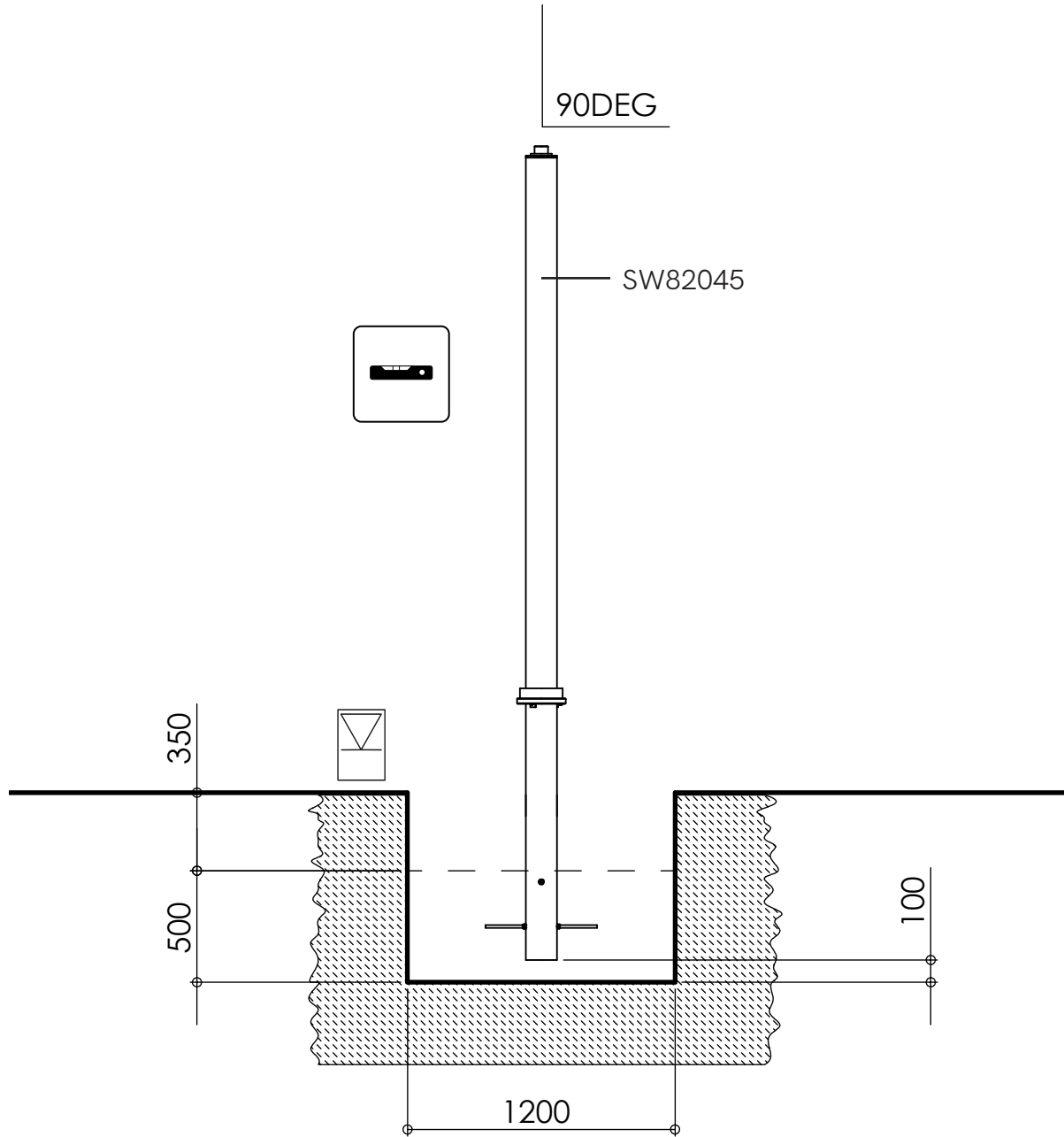
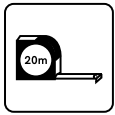

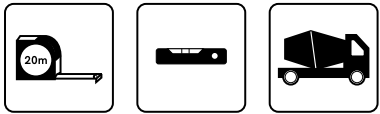

30N/mm²

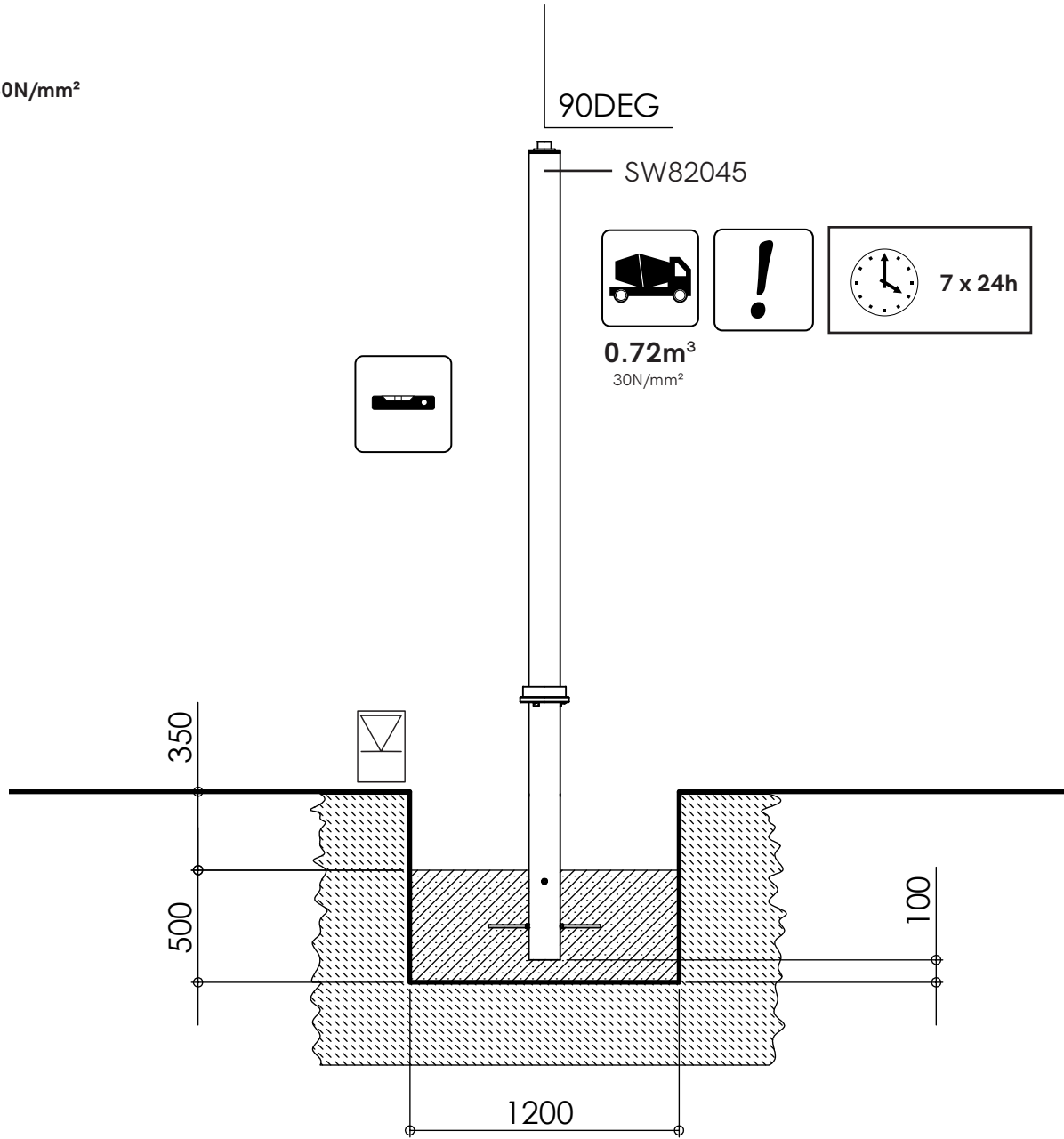
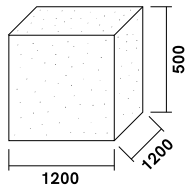

TAY- CC05-CC3000-00

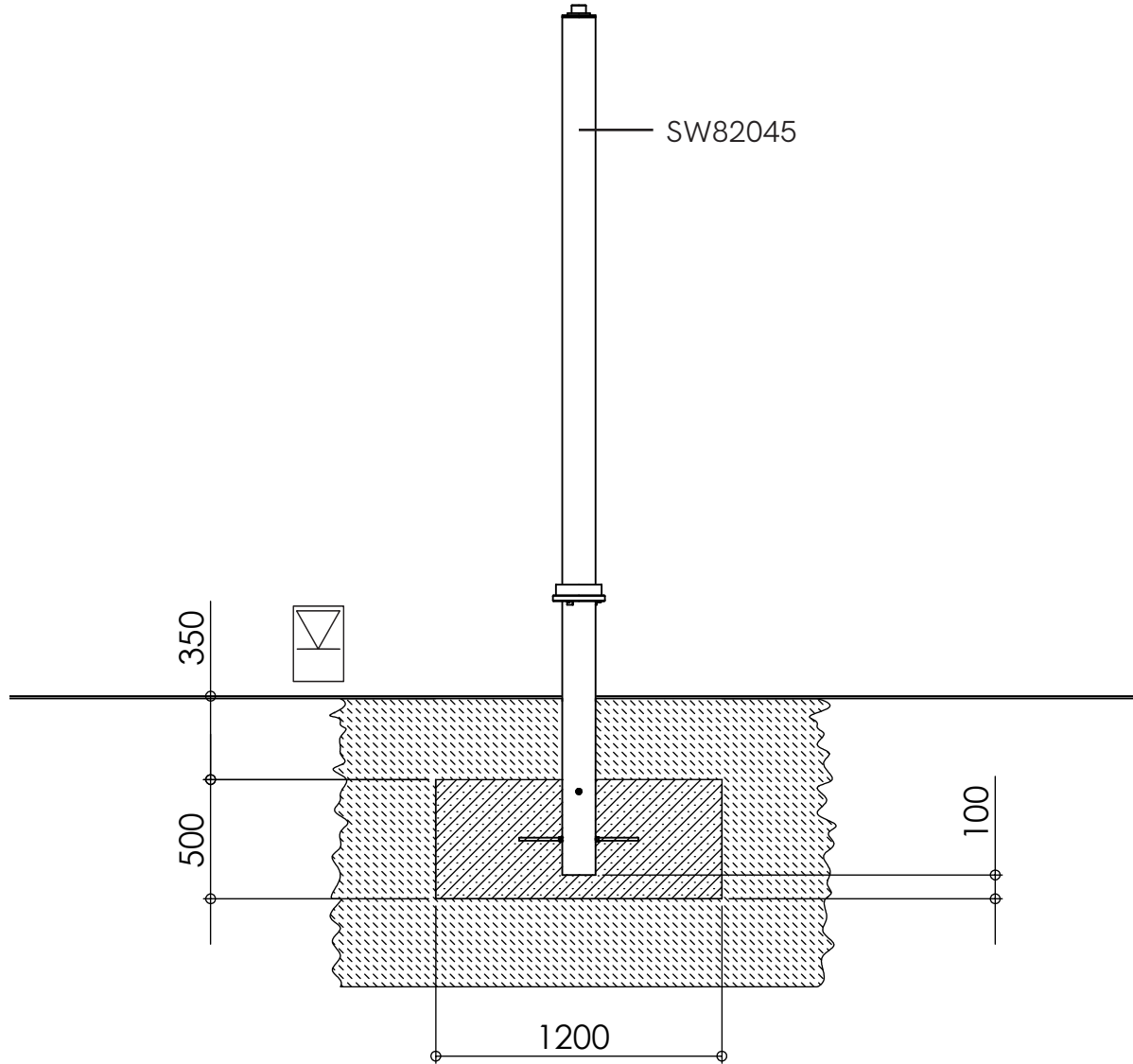

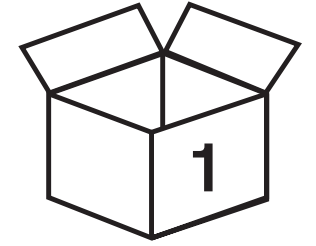
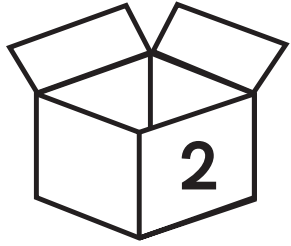

SW82016
TAY-51212

SW82740

SW81995

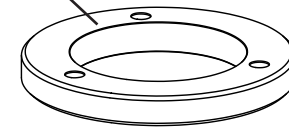
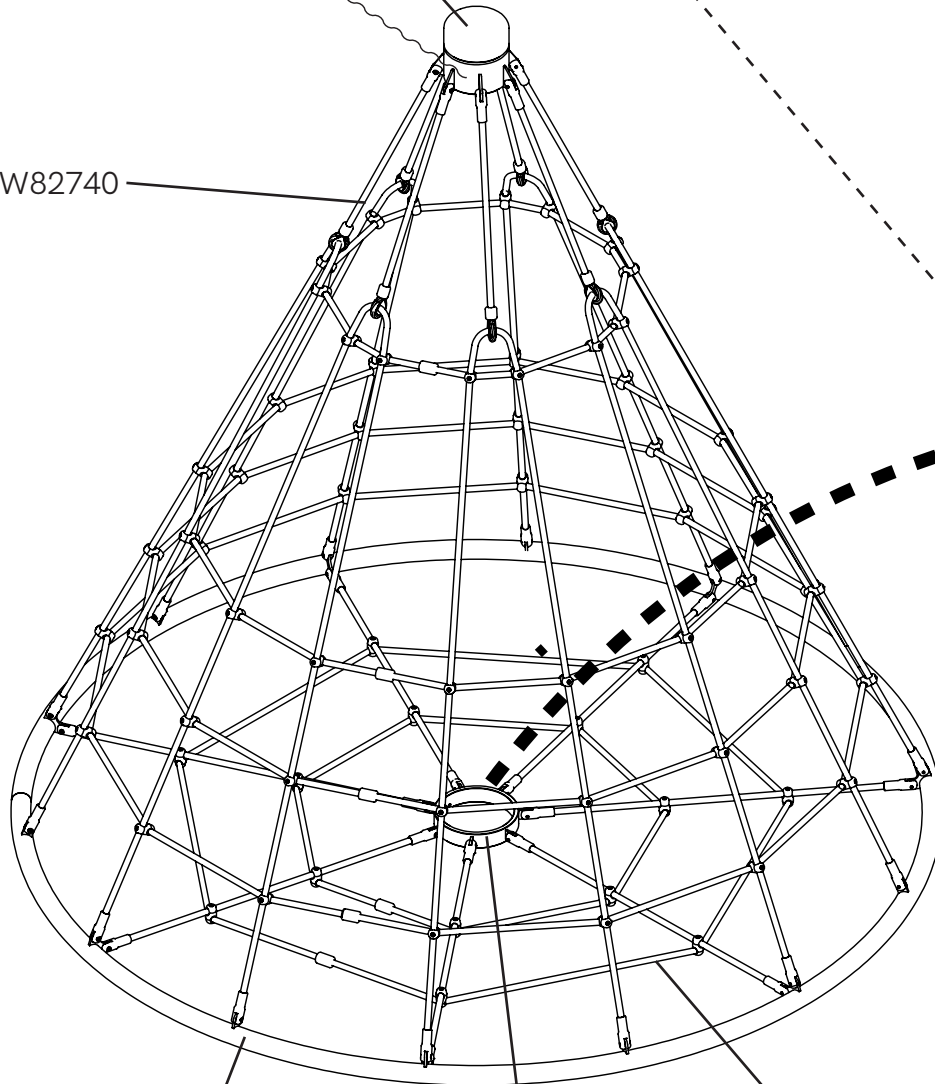

SW82063

SW82026

SW82724



S12



kg

46

S34



2-3

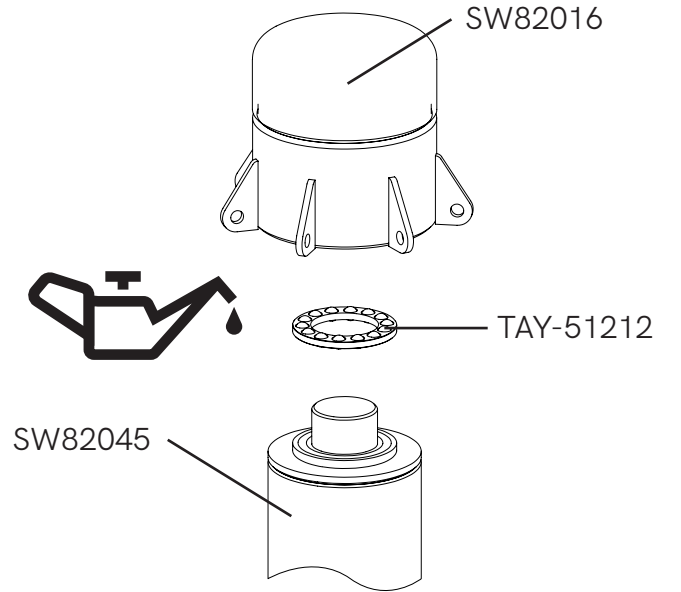
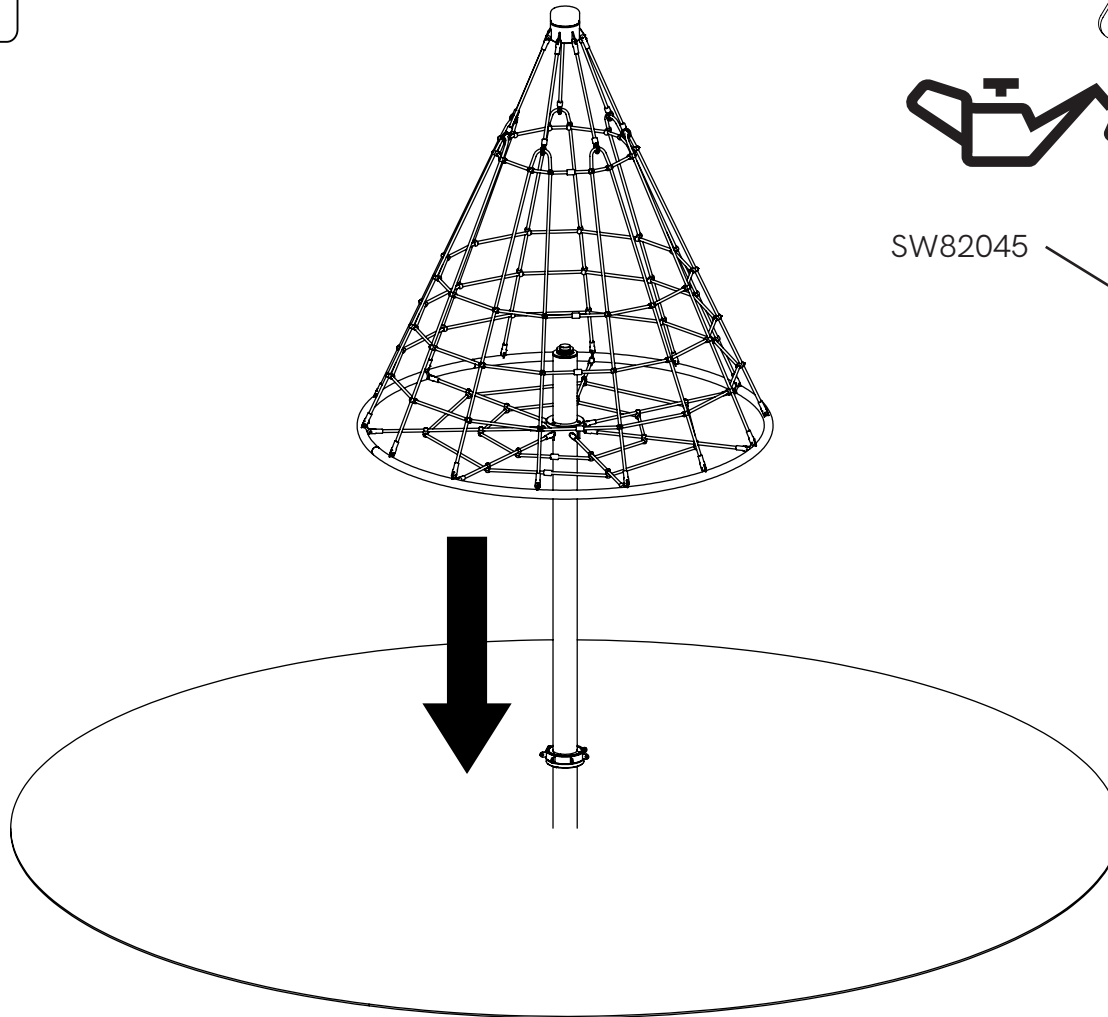

M8x100 A2 CSK SCS

M8 A2 NYLOC

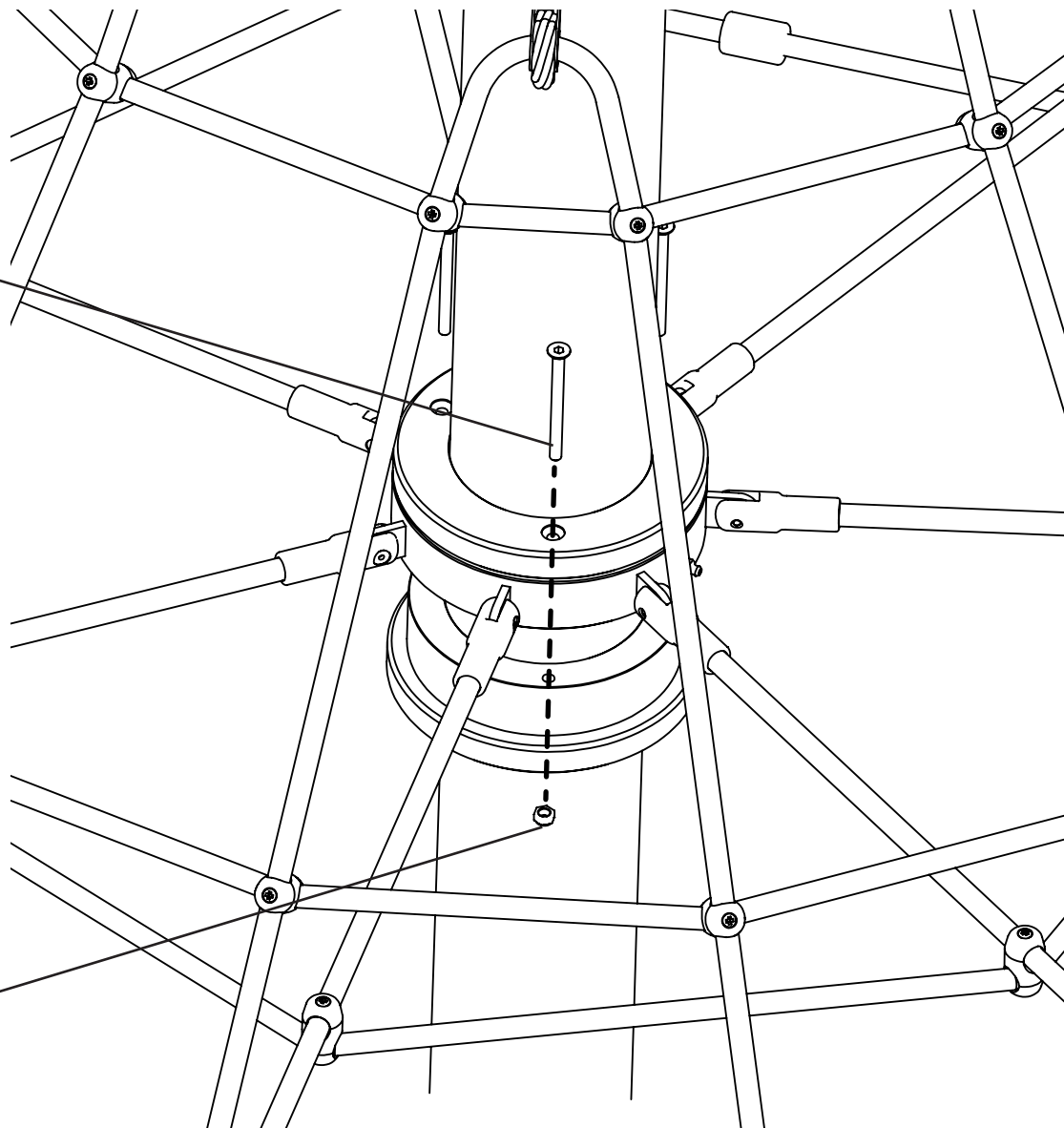

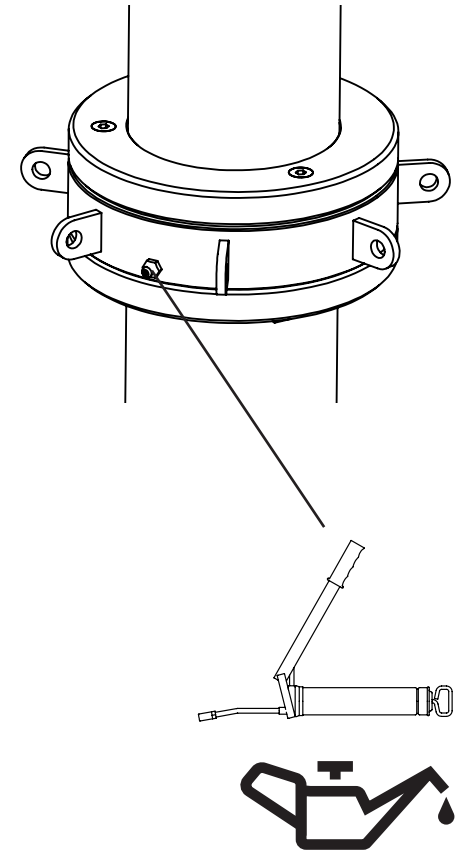
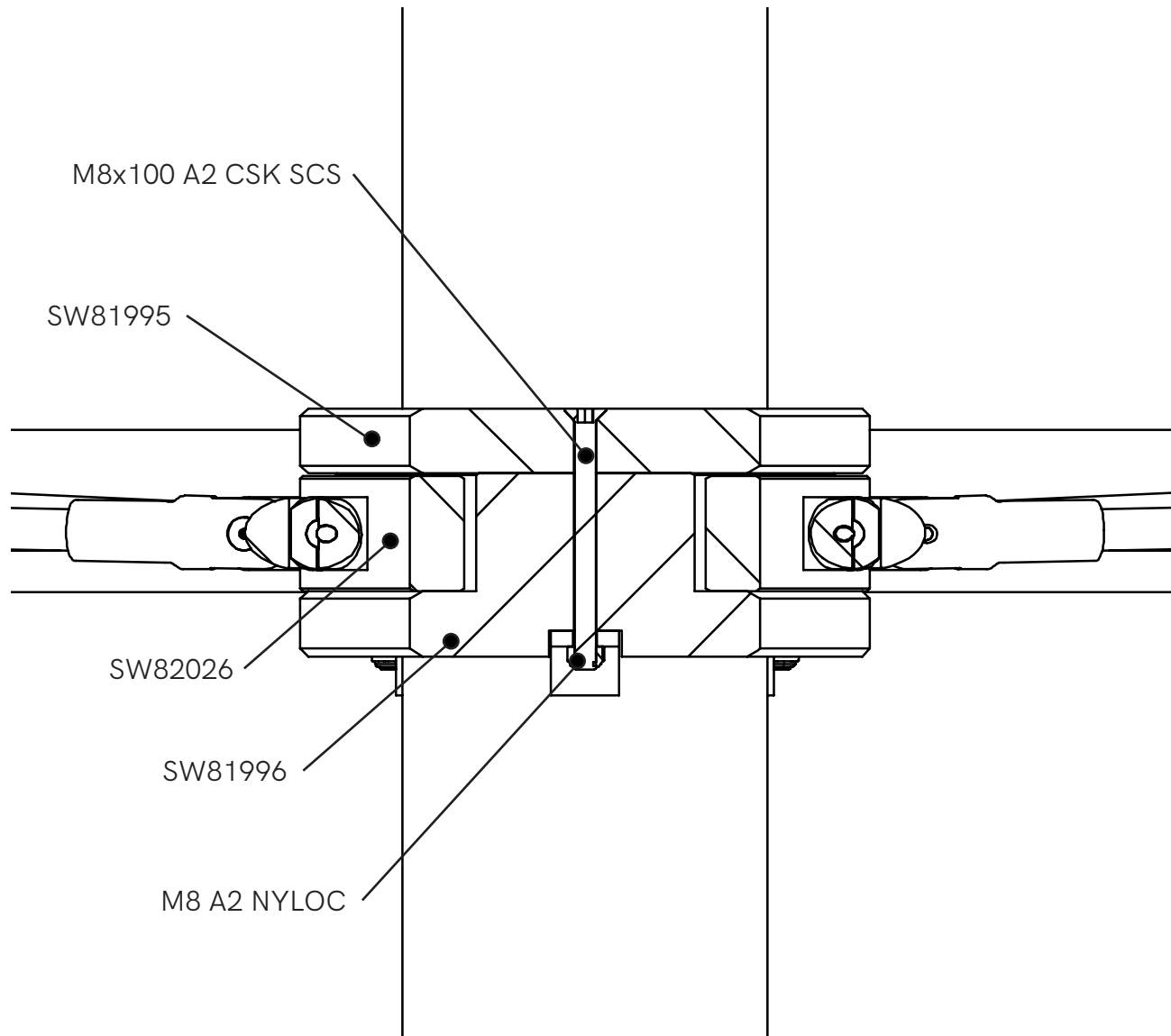

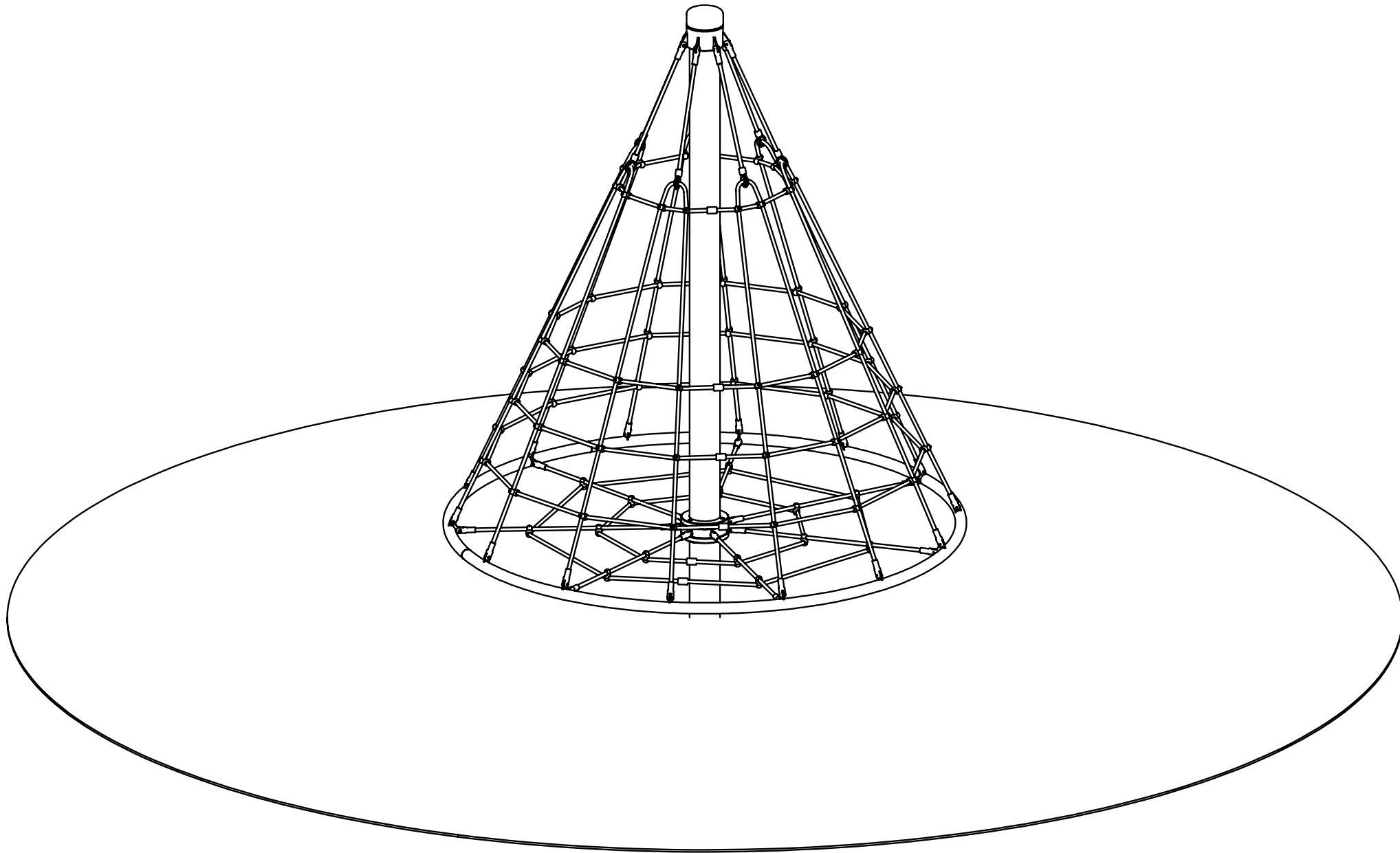



Tayplay Ltd

13A Riverview Business Park
Friarton Road
Perth
PH2 8DF
Scotland

Tel: +44 (0) 1738 449 084
Email: info@tayplay.com
Web: www.tayplay.com

